

## General Description

The AAT3238 MicroPower low dropout (LDO) linear regulator is ideally suited for portable applications where very fast transient response, extended battery life, and small size are critical. The AAT3238 has been specifically designed for high-speed turn-on and turn-off performance, fast transient response, good power supply ripple rejection (PSRR), and is reasonably low noise, making it ideal for powering sensitive circuits with fast switching requirements.

Other features include low quiescent current, typically 70µA, and low dropout voltage, typically less than 400mV at the maximum output current level of 300mA. The device is output short-circuit protected and has a thermal shutdown circuit for additional protection under extreme operating conditions.

The AAT3238 also features a low-power shutdown mode for extended battery life. A reference bypass pin has been provided to improve PSRR performance and output noise by connecting a small external capacitor from the AAT3238's reference output to ground.

The AAT3238 is available in a Pb-free, space-saving 6-pin SOT23 or 8-pin SC70JW package in factory-programmed voltages.

## Features

- Low Dropout: 400mV at 300mA
- Guaranteed 300mA Output
- High Accuracy:  $\pm 1.5\%$
- 70µA Quiescent Current
- Fast Line and Load Transient Response
- High-Speed Device Turn-On and Shutdown
- High Power Supply Ripple Rejection
- Low Self Noise
- Short-Circuit Protection
- Over-Temperature Protection
- Uses Low Equivalent Series Resistance (ESR) Ceramic Capacitors
- Noise Reduction Bypass Capacitor
- Shutdown Mode for Longer Battery Life
- Low Temperature Coefficient
- Factory-Programmed Output Voltages
- SOT23 6-Pin or SC70JW 8-Pin Package

## Applications

- Cellular Phones
- Digital Cameras
- Notebook Computers
- Personal Portable Electronics
- Portable Communication Devices

## Typical Application

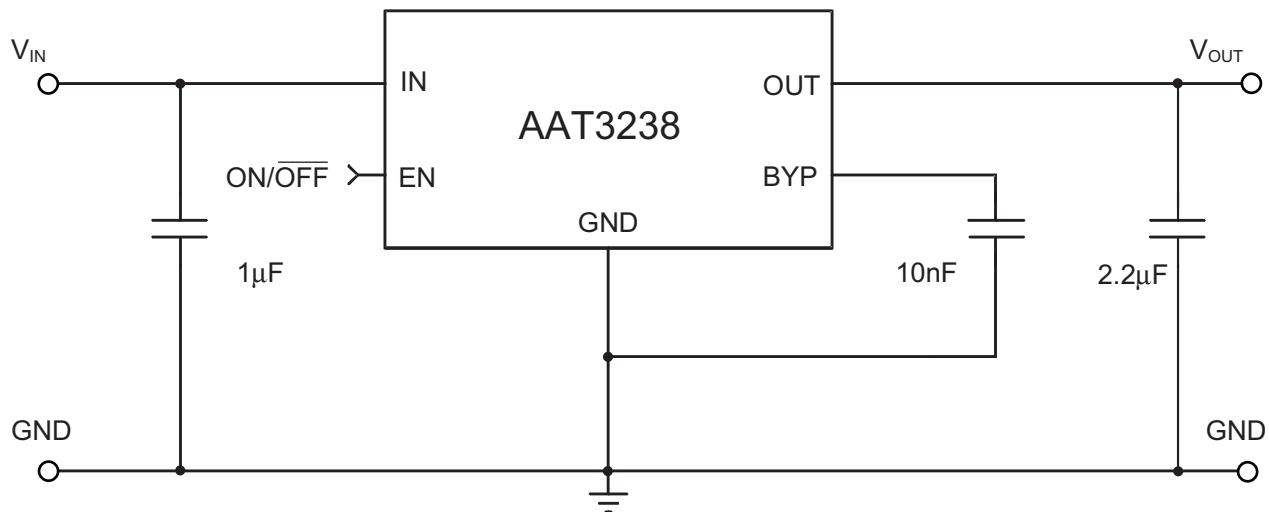

## Pin Descriptions

Pin #		Symbol	Function
SOT23-6	SC70JW-8		
1	5, 6	IN	Input voltage pin; should be decoupled with 1μF or greater capacitor.
2, 5	8	GND	Ground connection pin.
3	7	EN	Enable pin; this pin should not be left floating. When pulled low, the PMOS pass transistor turns off and all internal circuitry enters low-power mode, consuming less than 1μA.
4	1	BYP	Bypass capacitor connection; to improve AC ripple rejection, connect a 10nF capacitor to GND. This will also provide a soft-start function.
6	2, 3, 4	OUT	Output pin; should be decoupled with 2.2μF ceramic capacitor.

## Pin Configuration

**SOT23-6  
(Top View)**

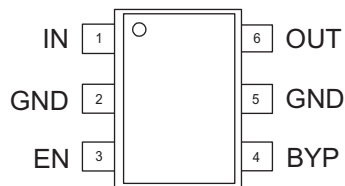

**SC70JW-8  
(Top View)**

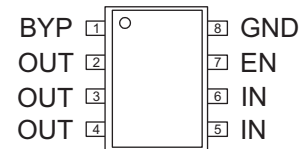



PowerLinear™

300mA MicroPower™ High Performance LDO Linear Regulator

## Absolute Maximum Ratings<sup>1</sup>

$T_A = 25^\circ\text{C}$ , unless otherwise noted.

Symbol	Description	Value	Units
$V_{IN}$	Input Voltage	6	V
$V_{ENIN(MAX)}$	Maximum EN to Input Voltage	0.3	V
$I_{OUT}$	DC Output Current	$P_D / (V_{IN} - V_O)$	mA
$T_J$	Operating Junction Temperature Range	-40 to 150	$^\circ\text{C}$

## Recommended Operating Conditions

Symbol	Description	Rating	Units
$V_{IN}$	Input Voltage	$(V_{OUT} + V_{DO})$ to 5.5	V
T	Ambient Temperature Range <sup>2</sup>	-40 to +85	$^\circ\text{C}$

## Thermal Information<sup>3</sup>

Symbol	Description	Rating	Units
$\Theta_{JA}$	Maximum Thermal Resistance	150	$^\circ\text{C}/\text{W}$
$P_D$	Maximum Power Dissipation	667	mW

1. Stresses above those listed in Absolute Maximum Ratings may cause permanent damage to the device. Functional operation at conditions other than the operating conditions specified is not implied. Only one Absolute Maximum Rating should be applied at any one time.

2. Mounted on a demo board.

3. To calculate minimum input voltage, use the following equation:  $V_{IN(MIN)} = V_{OUT(MAX)} + V_{DO(MAX)}$  as long as  $V_{IN} \geq 2.5\text{V}$ .



**Electrical Characteristics<sup>1</sup>**

$V_{IN} = V_{OUT(NOM)} + 1V$  for  $V_{OUT}$  options greater than 1.5V.  $V_{IN} = 2.5V$  for  $V_{OUT} \leq 1.5V$ .  $I_{OUT} = 1mA$ ,  $C_{OUT} = 2.2\mu F$ ,  $C_{IN} = 1\mu F$ ,  $T_A = -40^\circ C$  to  $+85^\circ C$ , unless otherwise noted. Typical values are  $T_A = 25^\circ C$ .

Symbol	Description	Conditions	Min	Typ	Max	Units	
$V_{OUT}$	Output Voltage Tolerance	$I_{OUT} = 1mA$ to $300mA$	$T_A = 25^\circ C$	-1.5		1.5	%
			$T_A = -40$ to $85^\circ C$	-2.5		2.5	
$I_{OUT}$	Output Current	$V_{OUT} > 1.2V$	300			mA	
$V_{DO}$	Dropout Voltage <sup>2, 3</sup>	$I_{OUT} = 300mA$		400	600	mV	
$I_{SC}$	Short-Circuit Current	$V_{OUT} < 0.4V$		600		mA	
$I_Q$	Ground Current	$V_{IN} = 5V$ , No Load, $EN = V_{IN}$	70	125		$\mu A$	
$I_{SD}$	Shutdown Current	$V_{IN} = 5V$ , $EN = 0V$			1	$\mu A$	
$\frac{\Delta V_{OUT}}{V_{OUT}} \cdot \Delta V_{IN}$	Line Regulation	$V_{IN} = V_{OUT} + 1$ to $5.0V$			0.09	%/V	
$\Delta V_{OUT}(\text{line})$	Dynamic Line Regulation	$V_{IN} = V_{OUT} + 1V$ to $V_{OUT} + 2V$ , $I_{OUT} = 300mA$ , $T_R/T_F = 2\mu s$		2.5		mV	
$\Delta V_{OUT}(\text{load})$	Dynamic Load Regulation	$I_{OUT} = 1mA$ to $300mA$ , $T_R < 5\mu s$		60		mV	
$t_{ENDLY}$	Enable Delay Time	$BYP = \text{Open}$		15		$\mu s$	
$V_{EN(L)}$	Enable Threshold Low				0.6	V	
$V_{EN(H)}$	Enable Threshold High		1.5			V	
$I_{EN}$	Leakage Current on Enable Pin	$V_{EN} = 5V$			1	$\mu A$	
PSRR	Power Supply Rejection Ratio	$I_{OUT} = 10mA$ , $C_{BYP} = 10nF$	1kHz	67		dB	
			10kHz	47			
			1MHz	45			
$T_{SD}$	Over-Temperature Shutdown Threshold			145		$^\circ C$	
$T_{HYS}$	Over-Temperature Shutdown Hysteresis			12		$^\circ C$	
$e_N$	Output Noise			50		$\mu V_{rms}$	
TC	Output Voltage Temperature Coefficient			22		ppm/ $^\circ C$	

1. The AAT3238 is guaranteed to meet performance specifications over the  $-40^\circ C$  to  $+85^\circ C$  operating temperature range and is assured by design, characterization, and correlation with statistical process controls.  
 2.  $V_{DO}$  is defined as  $V_{IN} - V_{OUT}$  when  $V_{OUT}$  is 98% of nominal.  
 3. For  $V_{OUT} < 2.1V$ ,  $V_{DO} = 2.5V - V_{OUT}$ .

## Typical Characteristics

Unless otherwise noted,  $V_{IN} = 5V$ ,  $T_A = 25^\circ C$ .

Output Voltage vs. Temperature

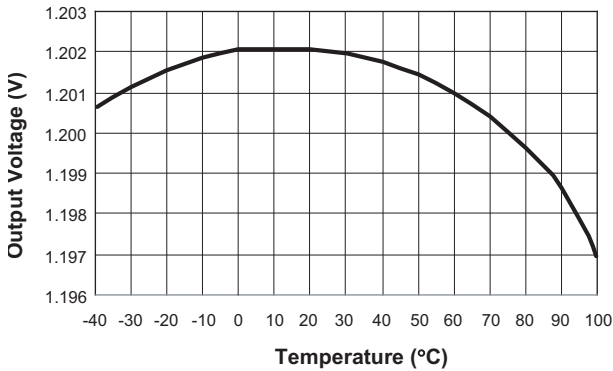

Dropout Characteristics

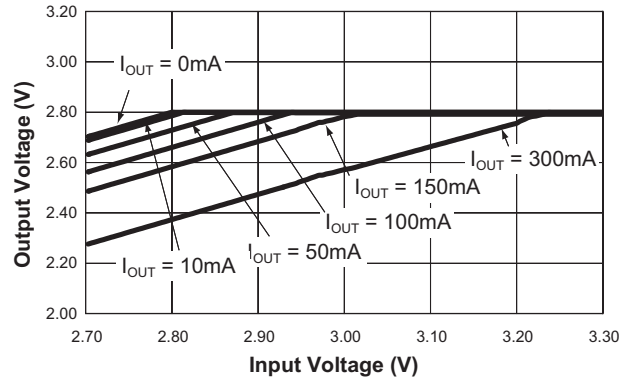

Dropout Voltage vs. Output Current

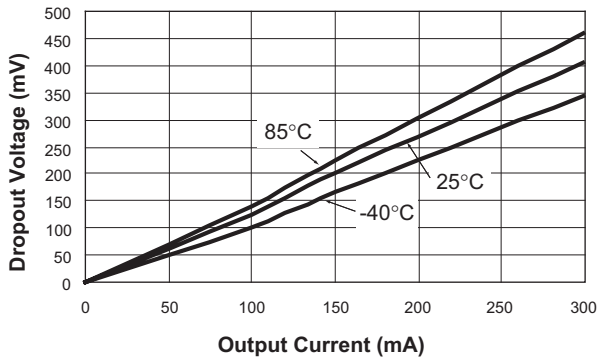

Ground Current vs. Input Voltage

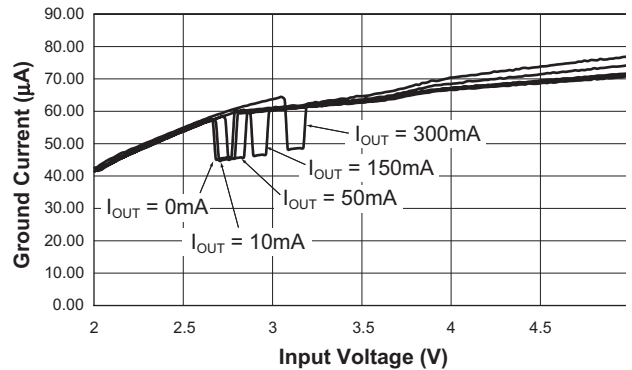

Quiescent Current vs. Temperature

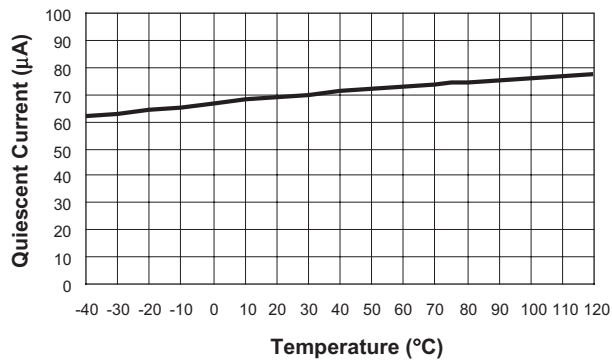

Output Voltage vs. Temperature

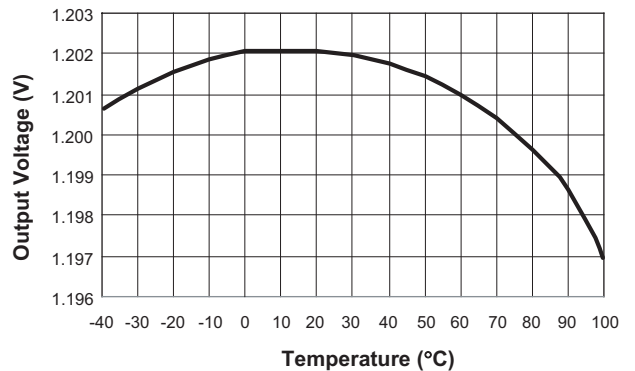

## Typical Characteristics

Unless otherwise noted,  $V_{IN} = 5V$ ,  $T_A = 25^\circ C$ .

**LDO Initial Power-Up Response Time**

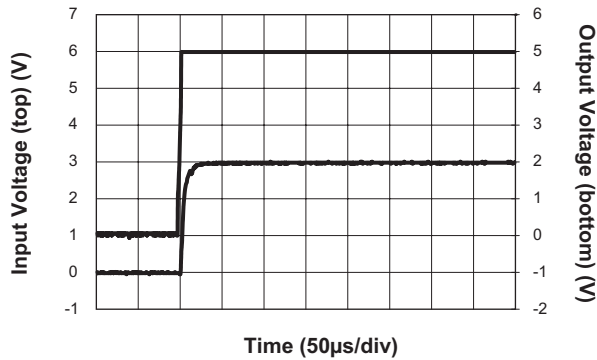

**Turn-Off Response Time**  
( $C_{BYP} = 10nF$ )

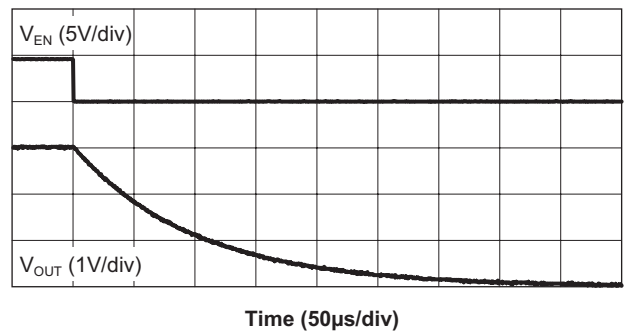

**Turn-On Time From Enable ( $V_{IN}$  present)**  
( $C_{BYP} = 10nF$ )

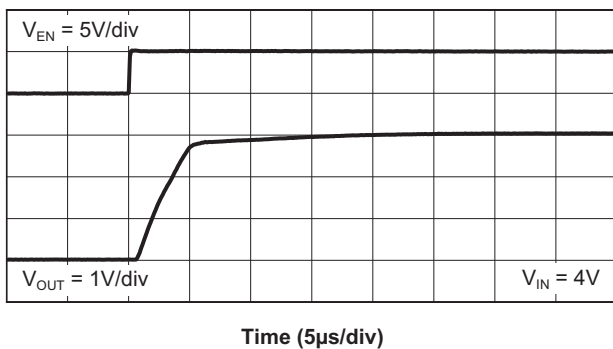

**Line Transient Response**

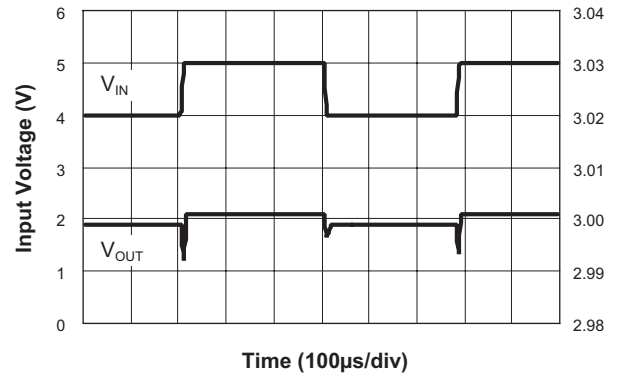

**Load Transient Response**

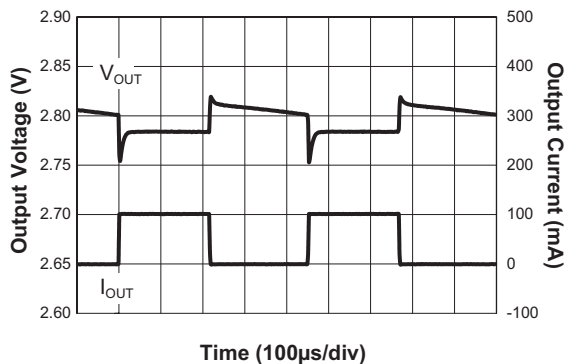

**Load Transient Response 300mA**

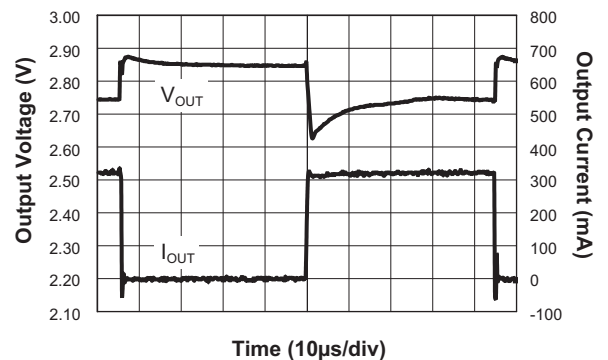

## Typical Characteristics

Unless otherwise noted,  $V_{IN} = 5V$ ,  $T_A = 25^\circ C$ .

**AAT3238 Self Noise**  
( $C_{OUT} = 10\mu F$ , Ceramic)

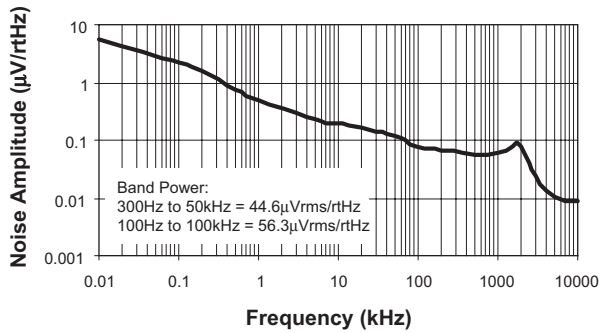

**Over-Current Protection**

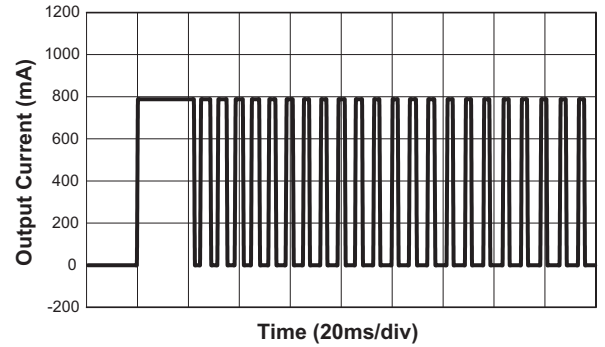

**$V_{IH}$  and  $V_{IL}$  vs.  $V_{IN}$**

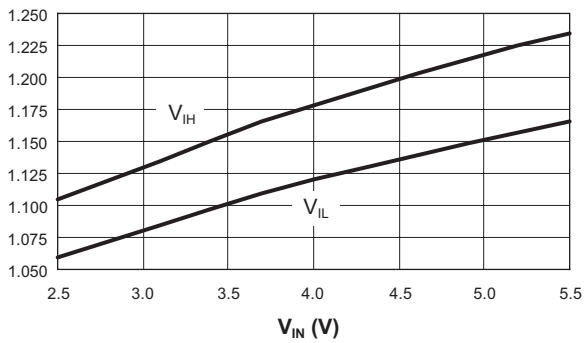

## Functional Block Diagram

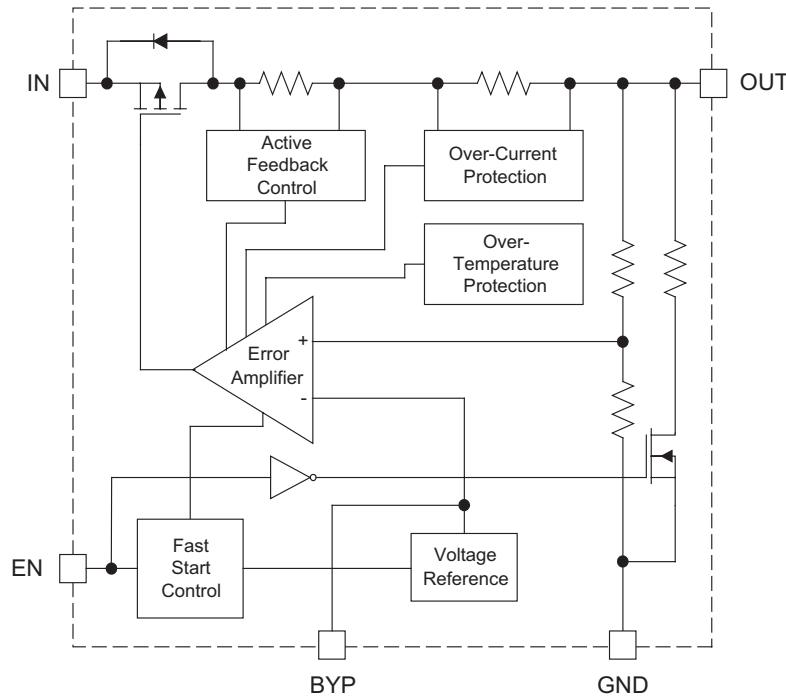

## Functional Description

The AAT3238 is intended for LDO regulator applications where output current load requirements range from no load to 300mA.

The advanced circuit design of the AAT3238 has been specifically optimized for very fast start-up and shut-down timing. This proprietary CMOS LDO has also been tailored for superior transient response characteristics. These traits are particularly important for applications that require fast power supply timing, such as GSM cellular telephone handsets.

The high-speed turn-on capability of the AAT3238 is enabled through the implementation of a fast start control circuit, which accelerates the power-up behavior of fundamental control and feedback circuits within the LDO regulator.

Fast turn-off response time is achieved by an active output pull-down circuit, which is enabled when the LDO regulator is placed in the shutdown mode. This active fast shutdown circuit has no adverse effect on normal device operation.

The AAT3238 has very fast transient response characteristics, which is an important feature for applications where fast line and load transient response is required.

This rapid transient response behavior is accomplished through the implementation of an active error amplifier feedback control. This proprietary circuit design is unique to this MicroPower LDO regulator.

The LDO regulator output has been specifically optimized to function with low-cost, low-ESR ceramic capacitors. However, the design will allow for operation over a wide range of capacitor types.

A bypass pin has been provided to allow the addition of an optional voltage reference bypass capacitor to reduce output self noise and increase power supply ripple rejection. Device self noise and PSRR will be improved by the addition of a small ceramic capacitor in this pin. However, increased values of  $C_{\text{BYPASS}}$  may slow down the LDO regulator turn-on time.

This LDO regulator has complete short-circuit and thermal protection. The integral combination of these two internal protection circuits gives the AAT3238 a comprehensive safety system to guard against extreme adverse operating conditions. Device power dissipation is limited to the package type and thermal dissipation properties. Refer to the Thermal Considerations section of this datasheet for details on device operation at maximum output current loads.



## Applications Information

To assure the maximum possible performance is obtained from the AAT3238, please refer to the following application recommendations.

### Input Capacitor

Typically, a 1 $\mu$ F or larger capacitor is recommended for  $C_{IN}$  in most applications. A  $C_{IN}$  capacitor is not required for basic LDO regulator operation. However, if the AAT3238 is physically located more than three centimeters from an input power source, a  $C_{IN}$  capacitor will be needed for stable operation.  $C_{IN}$  should be located as closely to the device  $V_{IN}$  pin as practically possible.  $C_{IN}$  values greater than 1 $\mu$ F will offer superior input line transient response and will assist in maximizing the highest possible power supply ripple rejection.

Ceramic, tantalum, or aluminum electrolytic capacitors may be selected for  $C_{IN}$ . There is no specific capacitor ESR requirement for  $C_{IN}$ . However, for 300mA LDO regulator output operation, ceramic capacitors are recommended for  $C_{IN}$  due to their inherent capability over tantalum capacitors to withstand input current surges from low impedance sources such as batteries in portable devices.

### Output Capacitor

For proper load voltage regulation and operational stability, a capacitor is required between pins  $V_{OUT}$  and GND. The  $C_{OUT}$  capacitor connection to the LDO regulator ground pin should be made as direct as practically possible for maximum device performance.

The AAT3238 has been specifically designed to function with very low ESR ceramic capacitors. For best performance, ceramic capacitors are recommended.

Typical output capacitor values for maximum output current conditions range from 1 $\mu$ F to 10 $\mu$ F. Applications utilizing the exceptionally low output noise and optimum power supply ripple rejection characteristics of the AAT3238 should use 2.2 $\mu$ F or greater for  $C_{OUT}$ . If desired,  $C_{OUT}$  may be increased without limit.

In low output current applications where output load is less than 10mA, the minimum value for  $C_{OUT}$  can be as low as 0.47 $\mu$ F.

### Bypass Capacitor and Low Noise Applications

A bypass capacitor pin is provided to enhance the low noise characteristics of the AAT3238 LDO regulator. The bypass capacitor is not necessary for operation of the AAT3238. However, for best device performance, a small ceramic capacitor should be placed between the bypass pin (BYP) and the device ground pin (GND). The value of  $C_{BYP}$  may range from 470pF to 10nF. For lowest noise and best possible power supply ripple rejection performance, a 10nF capacitor should be used. To practically realize the highest power supply ripple rejection and lowest output noise performance, it is critical that the capacitor connection between the BYP pin and GND pin be direct and PCB traces should be as short as possible. Refer to the PCB Layout Recommendations section of this document for examples.

There is a relationship between the bypass capacitor value and the LDO regulator turn-on and turn-off time. In applications where fast device turn-on and turn-off time are desired, the value of  $C_{BYP}$  should be reduced.

In applications where low noise performance and/or ripple rejection are less of a concern, the bypass capacitor may be omitted. The fastest device turn-on time will be realized when no bypass capacitor is used.

DC leakage on this pin can affect the LDO regulator output noise and voltage regulation performance. For this reason, the use of a low leakage, high quality ceramic (NPO or COG type) or film capacitor is highly recommended.

### Capacitor Characteristics

Ceramic composition capacitors are highly recommended over all other types of capacitors for use with the AAT3238. Ceramic capacitors offer many advantages over their tantalum and aluminum electrolytic counterparts. A ceramic capacitor typically has very low ESR, is lower cost, has a smaller PCB footprint, and is non-polarized. Line and load transient response of the LDO regulator is improved by using low-ESR ceramic capacitors. Since ceramic capacitors are non-polarized, they are not prone to incorrect connection damage.

### Equivalent Series Resistance

ESR is a very important characteristic to consider when selecting a capacitor. ESR is the internal series resistance associated with a capacitor that includes lead resistance, internal connections, size and area, material composition, and ambient temperature. Typically, capacitor ESR

is measured in milliohms for ceramic capacitors and can range to more than several ohms for tantalum or aluminum electrolytic capacitors.

### **Ceramic Capacitor Materials**

Ceramic capacitors less than 0.1 $\mu$ F are typically made from NPO or COG materials. NPO and COG materials generally have tight tolerance and are very stable over temperature. Larger capacitor values are usually composed of X7R, X5R, Z5U, or Y5V dielectric materials. These two material types are not recommended for use with LDO regulators since the capacitor tolerance can vary more than  $\pm 50\%$  over the operating temperature range of the device. A 2.2 $\mu$ F Y5V capacitor could be reduced to 1 $\mu$ F over temperature; this could cause problems for circuit operation. X7R and X5R dielectrics are much more desirable. The temperature tolerance of X7R dielectric is better than  $\pm 15\%$ .

Capacitor area is another contributor to ESR. Capacitors that are physically large in size will have a lower ESR when compared to a smaller sized capacitor of an equivalent material and capacitance value. These larger devices can improve circuit transient response when compared to an equal value capacitor in a smaller package size.

Consult capacitor vendor datasheets carefully when selecting capacitors for LDO regulators.

### **Enable Function**

The AAT3238 features an LDO regulator enable/disable function. This pin (EN) is active high and is compatible with CMOS logic. To assure the LDO regulator will switch on, the EN turn-on control level must be greater than 1.5V. The LDO regulator will go into the disable shutdown mode when the voltage on the EN pin falls below 0.6V. If the enable function is not needed in a specific application, it may be tied to  $V_{IN}$  to keep the LDO regulator in a continuously on state.

When the LDO regulator is in shutdown mode, an internal 1.5k $\Omega$  resistor is connected between  $V_{OUT}$  and GND. This is intended to discharge  $C_{OUT}$  when the LDO regulator is disabled. The internal 1.5k $\Omega$  has no adverse effect on device turn-on time.

### **Short-Circuit Protection**

The AAT3238 contains an internal short-circuit protection circuit that will trigger when the output load current exceeds the internal threshold limit. Under short-circuit

conditions, the output of the LDO regulator will be current limited until the short-circuit condition is removed from the output or the LDO regulator package power dissipation exceeds the device thermal limit.

### **Thermal Protection**

The AAT3238 has an internal thermal protection circuit which will turn on when the device die temperature exceeds 145°C. The internal thermal protection circuit will actively turn off the LDO regulator output pass device to prevent the possibility of over-temperature damage. The LDO regulator output will remain in a shutdown state until the internal die temperature falls back below the 145°C trip point.

The combination and interaction between the short-circuit and thermal protection systems allow the LDO regulator to withstand indefinite short-circuit conditions without sustaining permanent damage.

### **No-Load Stability**

The AAT3238 is designed to maintain output voltage regulation and stability under operational no-load conditions. This is an important characteristic for applications where the output current may drop to zero.

### **Reverse Output-to-Input Voltage Conditions and Protection**

Under normal operating conditions, a parasitic diode exists between the output and input of the LDO regulator. The input voltage should always remain greater than the output load voltage, maintaining a reverse bias on the internal parasitic diode. Conditions where  $V_{OUT}$  might exceed  $V_{IN}$  should be avoided since this would forward bias the internal parasitic diode and allow excessive current flow into the  $V_{OUT}$  pin, possibly damaging the LDO regulator.

In applications where there is a possibility of  $V_{OUT}$  exceeding  $V_{IN}$  for brief amounts of time during normal operation, the use of a larger value  $C_{IN}$  capacitor is highly recommended. A larger value of  $C_{IN}$  with respect to  $C_{OUT}$  will effect a slower  $C_{IN}$  decay rate during shutdown, thus preventing  $V_{OUT}$  from exceeding  $V_{IN}$ . In applications where there is a greater danger of  $V_{OUT}$  exceeding  $V_{IN}$  for extended periods of time, it is recommended to place a Schottky diode across  $V_{IN}$  to  $V_{OUT}$  (connecting the cathode to  $V_{IN}$  and anode to  $V_{OUT}$ ). The Schottky diode forward voltage should be less than 0.45V.

## Ordering Information

Output Voltage	Package	Marking <sup>1</sup>	Part Number (Tape and Reel) <sup>2</sup>
1.2V	SOT23-6	KIXYY	AAT3238IGU-1.2-T1
1.5V	SOT23-6	JGXYY	<b>AAT3238IGU-1.5-T1</b>
1.6V	SOT23-6	JSXYY	<b>AAT3238IGU-1.6-T1</b>
1.8V	SOT23-6	JRXYY	<b>AAT3238IGU-1.8-T1</b>
1.85V	SOT23-6	JFXYY	<b>AAT3238IGU-1.85-T1</b>
2.0V	SOT23-6		AAT3238IGU-2.0-T1
2.3V	SOT23-6		AAT3238IGU-2.3-T1
2.5V	SOT23-6	KUXYY	<b>AAT3238IGU-2.5-T1</b>
2.7V	SOT23-6		AAT3238IGU-2.7-T1
2.8V	SOT23-6		AAT3238IGU-2.8-T1
2.85	SOT23-6	QGXY	<b>AAT3238IGU-2.85-T1</b>
3.0V	SOT23-6		AAT3238IGU-3.0-T1
3.3V	SOT23-6		AAT3238IGU-3.3-T1
3.5V	SOT23-6		AAT3238IGU-3.5-T1
1.2V	SC70JW-8	KIXYY	<b>AAT3238IJS-1.2-T1</b>
1.45V	SC70JW-8		AAT3238IJS-1.45-T1
1.5V	SC70JW-8	JGXYY	<b>AAT3238IJS-1.5-T1</b>
1.8V	SC70JW-8		AAT3238IJS-1.8-T1
2.0V	SC70JW-8		AAT3238IJS-2.0-T1
2.3V	SC70JW-8		AAT3238IJS-2.3-T1
2.5V	SC70JW-8		AAT3238IJS-2.5-T1
2.7V	SC70JW-8		AAT3238IJS-2.7-T1
2.8V	SC70JW-8	FCXY	<b>AAT3238IJS-2.8-T1</b>
2.85	SC70JW-8		AAT3238IJS-2.85-T1
3.0V	SC70JW-8	VOXY	<b>AAT3238IJS-3.0-T1</b>
3.3V	SC70JW-8		AAT3238IJS-3.3-T1
3.5V	SC70JW-8		AAT3238IJS-3.5-T1



All AnalogicTech products are offered in Pb-free packaging. The term "Pb-free" means semiconductor products that are in compliance with current RoHS standards, including the requirement that lead not exceed 0.1% by weight in homogeneous materials. For more information, please visit our website at <http://www.analogictech.com/about/quality.aspx>.

1. XYY = assembly and date code.

2. Sample stock is generally held on part numbers listed in **BOLD**.

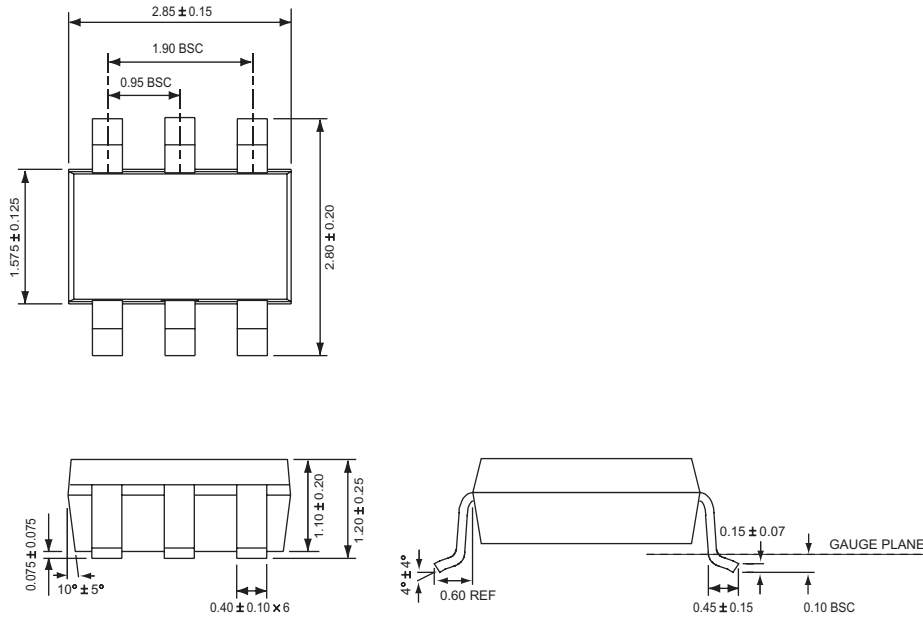
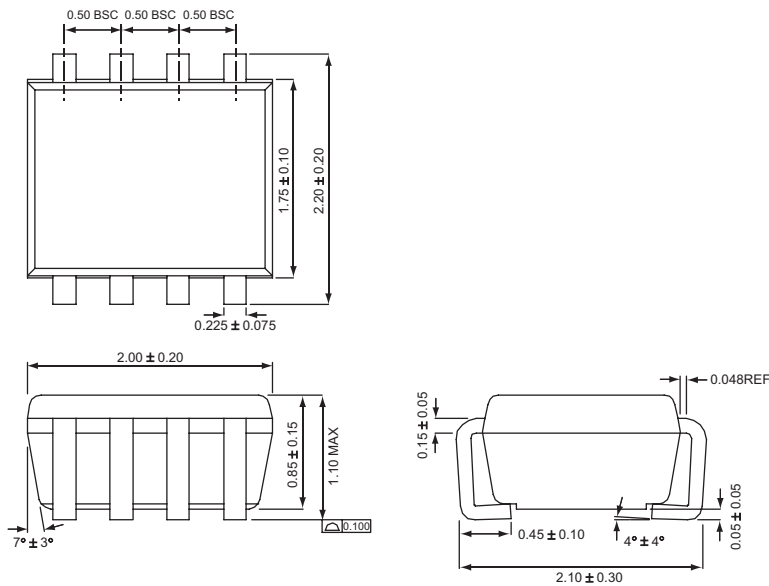
**Package Information**
**SOT23-6**

**SC70JW-8**

All dimensions in millimeters.

**AAT3238****PowerLinear™****300mA MicroPower™ High Performance LDO Linear Regulator**

**Advanced Analogic Technologies, Inc.**  
3230 Scott Boulevard, Santa Clara, CA 95054  
Phone (408) 737-4600  
Fax (408) 737-4611



© Advanced Analogic Technologies, Inc.  
AnalogicTech cannot assume responsibility for use of any circuitry other than circuitry entirely embodied in an AnalogicTech product. No circuit patent licenses, copyrights, mask work rights, or other intellectual property rights are implied. AnalogicTech reserves the right to make changes to their products or specifications or to discontinue any product or service without notice. Except as provided in AnalogicTech's terms and conditions of sale, AnalogicTech assumes no liability whatsoever, and AnalogicTech disclaims any express or implied warranty relating to the sale and/or use of AnalogicTech products including liability or warranties relating to fitness for a particular purpose, merchantability, or infringement of any patent, copyright or other intellectual property right. In order to minimize risks associated with the customer's applications, adequate design and operating safeguards must be provided by the customer to minimize inherent or procedural hazards. Testing and other quality control techniques are utilized to the extent AnalogicTech deems necessary to support this warranty. Specific testing of all parameters of each device is not necessarily performed. AnalogicTech and the AnalogicTech logo are trademarks of Advanced Analogic Technologies Incorporated. All other brand and product names appearing in this document are registered trademarks or trademarks of their respective holders.